



TRIMURTI®

SUNDARTA KI PEHCHAN



ABOUT US

Trimurti is more than a construction materials brand—we're a trusted partner in building modern India. Since 2004, we've specialized in gypsum plaster, wall putty, tile care, and more, delivering solutions rooted in quality, reliability, and innovation. With a strong presence across India and exports abroad, our ISO and ISI-certified products are crafted in advanced facilities in Rajasthan. Backed by 150+ professionals and a vast network of 5000+ retailers, we're committed to timely delivery, international standards, and helping every project stand strong, beautiful, and budget-friendly.



MILESTONES »

Got ISI marked approval for Gypsum Plaster

> 2007

Set up Wall Putty plant in Alwar with 3000 ton production

> 2014

Achieved Nation Wide Award for the Best Emerging Co. of the year by Forbes India

> 2020

> 2004

1st P.O.P plant producing 9600 ton P.O.P a year

> 2012

Introduced One Coat Gypsum Plaster & Quick Bond.

> 2019

Introduced False Ceiling products & got ISI marked approval for Wall Putty.



OUR VISION

We aim to be the most trusted partner in construction by delivering premium materials, seamless service, and expert support. Our commitment lies in building lasting client relationships through consistent quality and reliability. With a focus on excellence and customer satisfaction, we guide every project with integrity and care. Together, we help clients bring their visions to life—one project at a time, one trusted partnership at a time.

Got GEA 2022 Award for Best P.O.P and Wall Putty manufacturer in North Delhi by Bollywood Actor (Anupam Kher) & got ISI marked in Tile Adhesive.

Introduced Shakti Kapoor as the newest face of Trimurti

› 2022

› 2024

› 2021

Launched an exclusive range of Decorative White Cement & Tile Adhesive.

› 2023

Set up new plant in alwar & launched an exclusive range of tile care products.

› 2025

Introduced Waterproofing Chemical & Paints Range. Awarded by minister of RTHI Nitin Gadkari.



OUR STORY

Founded in 2004 by Shri Manik Gupta and Shri Rahul Gupta, Trimurti began with a simple yet powerful vision—to craft world-class wall care solutions that support the Make in India movement. What started as a small flame has now become a guiding light in the industry. With **150+ professionals**, cutting-edge manufacturing in Rajasthan, and a robust network of **250+ distributors and 5000+ retailers**, Trimurti stands tall as a trusted name in gypsum plaster, wall putty, and tile care. Our commitment to quality, innovation, and timely delivery makes us a one-stop destination for modern construction needs.

FOUNDERS' MESSAGE



At Trimurti, customer satisfaction drives everything we do. We focus on building lasting relationships by understanding each client's unique needs. More than just delivering products, we aim to create meaningful solutions. For us, a satisfied customer is the strongest brand ambassador. We're not just building for today—we're shaping a greener, brighter future, one relationship at a time.

Mr. Manik Gupta
Director



Trimurti was founded to empower people to build their dreams and create beautiful, unique spaces. Our products combine strength, sustainability, and aesthetics to elevate every structure. Committed to excellence, we not only craft top-quality materials but also ensure timely distribution and global export, without ever compromising on quality.

Mr. Rahul Gupta
Director

INFRASTRUCTURE

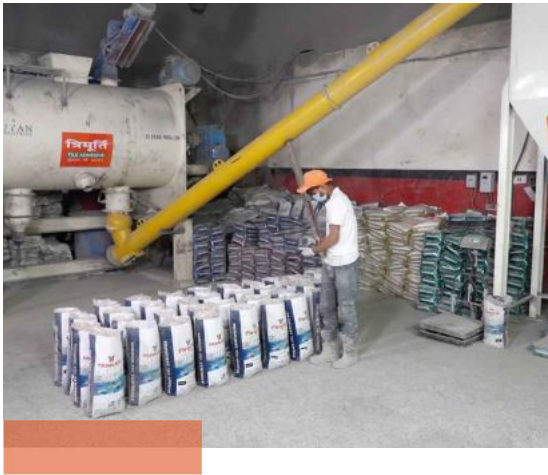

Strong Infrastructure Backed by Strategic Excellence

Trimurti has witnessed rapid growth, anchored by its headquarters in New Delhi. Our state-of-the-art manufacturing facility spans an impressive 15,000 sq. meters in Bikaner, Rajasthan—situated near India's finest raw gypsum mines. To boost productivity and meet rising demand, we also operate a plant in the industrial hub of Alwar. Equipped with advanced machinery and staffed by industry experts, our facilities combine vast scale with precision. Supported by cutting-edge laboratories, we ensure consistent, high-quality production around the clock, every day of the year.



OUR PRESENCE





INDIA'S MOST TRUSTED WALL CARE BRAND

With over **20 years of experience**, Trimurti stands at the forefront of wall care solutions in India. Backed by advanced in-house R&D and stringent quality labs, we deliver only **ISO and ISI-certified products** you can rely on. Our eco-conscious manufacturing reflects our commitment to a greener future, while our expansive distribution network ensures timely delivery nationwide. Trusted by leading builders and top brands, Trimurti is your partner for durable, high-quality wall care.



Comprehensive Product Range:

From wall putty to waterproofing solutions, we offer a one-stop shop for all your construction needs.



Quality Assurance:

Our products undergo stringent quality checks to ensure durability and performance.



Sustainability Focus:

We are committed to environmentally friendly practices, offering green-certified products.



Customer-Centric Approach:

Our team provides expert guidance and support to ensure your project's success.

OUR CLIENTS

			
 दिल्ली मेट्रो रेल कॉर्पोरेशन लिमिटेड Delhi Metro Rail Corporation Limited			 HOTELS · PALACES · RESORTS · SAFARIS
			
			
 JMC PROJECTS (INDIA) LIMITED (A Jubilant Group Enterprise)		 DUSIT DEVARANA NEW DELHI A RIED GROUP RESORT	
			
			
			

CERTIFICATIONS



ISO 9001:2015

Quality Management Systems



ISO 14001:2015

Environmental Management Systems



Indian Green Building Council

Eco-friendly and sustainable products

AWARDS



2022
Global
Excellence Award

By Anupam Kher
(Bollywood Actor)



2023
Global
Excellence Award

By Madhuri Dixit
(Bollywood Actress)



2024
Introduced
Bollywood Actor

Shakti Kapoor

As the brand face of Trimurti



2025
Famous Award

By Nitin Gadkari
(Minister of Road Transport
and Highways of India)



पक्का जोड़ **और**
मज़बूती ज़्यादा
है त्रिमूर्ति का 
पक्का वादा



FINISHES

01

Premium Gypsum Plaster

02

Expert Gypsum Plaster

03

Platinum Gypsum Plaster

04

Silk Gypsum Plaster

05

One Coat Gypsum Plaster

06

Superior Quick Bond

07

Expert Quick Bond

08

GI Gypsum Board & P.O.P Channel

09

GI P.O.P Wire Mesh

10

Dry Wall Screw

11

Fastener

12

Keel

13

Washer

14

Premium T Grid

15

Celing Tiles

16

Gypsum Board

17

Drywall Tape

18

Gypsum Jointing Compound

19

Premium Wall Putty

20

Superior Wall Putty

21

Expert Wall Putty

22

Silk Wall Putty

23

Waterproof Wall Putty

24

Wall Putty Tonic

25

Decorative White Cement

26

Pearl White Wash

27

Croma Acrylic Distemper

28

Primer Paint Coat (Interior)

29

Primer Shield (Exterior)

30

Elegant Emulsion (Interior)

S T I L E T E C H N I C S

31

Fusion Emulsion (Exterior)

32

Elegant Shyne Emulsion (Interior)

33

Fusion Shyne Emulsion (Exterior)

34

Universal Stainer

35

Hydroproof Waterproofing Solution

36

Aquacrete Waterproofing Solution

37

Premium Grey Cement

38

Tile Adhesive Silver Series

39

Tile Adhesive Silver Plus Series

40

Tile Adhesive Gold Series

41

Tile Adhesive Gold Plus Series

42

Tile Adhesive Diamond Series

43

Tile/Cement Bonder

44

Tile Grout (unsanded)

45

Tile Grout Admix

46

Epoxy Grout (3 Component)

47

Epoxy Grout (2 Component)

48

Tile Cleaner

49

Marble Cleaner

50

Tile Spacer

51

Notch Trowel

52

Ready Mix Plaster

53

Brick Joining Mortar

54

AAC Block Joining Mortar

The
Rare Gem
FOR
FLAWLESS FINISHES



PREMIUM GYPSUM PLASTER

Trimurti Premium Gypsum Plaster is a high-quality white powder made from heated gypsum, ideal for internal wall plastering, ceilings, and decorative work like cornices and mouldings. It offers slow setting, extra coverage, and is free from impurities, saving time and effort in application.



Smooth Finish



Less Paint Consumption



Less Residue



Perfect Setting Time



SPECIFICATIONS

Setting Time	:	15-20 Min.
Residue	:	4%-5%
Whiteness	:	68%-70%
Wastage	:	NIL
Tensile Strength (kg/cm ²)	:	35-40
Compressive Strength (N/mm ²)	:	5-7
Density (kg/m ³)	:	750-800
Chemical Composition	:	Calcium Sulphate Hemihydrate [CaSO ₄ .1/2H ₂ O]
Material (1 kg)	:	0.7 Ltr. Water

COVERAGE

1 KG COVERS
1 SQ.FT. with 12MM THICKNESS

STORAGE & SHELF LIFE

12 MONTHS
from the date of manufacturing
when stored in dry conditions.

PACKAGING



EXPERT GYPSUM PLASTER

Trimurti Expert Gypsum Plaster is a premium-grade plaster that offers smooth, durable, and crack-free wall finishes. Made from high-quality gypsum, it ensures strong bonding, easy application, and minimal wastage. Ideal for interiors, it provides a perfect white finish ready for painting without extra layers.



Smooth
Finish



Less Paint
Consumption



Super White &
Super Strength



Extra
Coverage

SPECIFICATIONS

Setting Time	:	15-20 Min.
Residue	:	2%-4%
Whiteness	:	70%-72%
Wastage	:	NIL
Tensile Strength (kg/cm ²)	:	40-42
Compressive Strength (N/mm ²)	:	6-8
Density (kg/m ³)	:	700-750
Chemical Composition	:	Calcium Sulphate Hemihydrate [CaSO ₄ .1/2H ₂ O]
Material (1 kg)	:	0.7 Ltr. Water

COVERAGE

1 KG COVERS
1.25 SQ.FT. with 12MM THICKNESS

STORAGE & SHELF LIFE

12 MONTHS

from the date of manufacturing
when stored in dry conditions.

PACKAGING

25 KG

PLATINUM GYPSUM PLASTER

Trimurti Platinum Gypsum Plaster is a next-generation wall finish made from high-purity gypsum. It provides a smooth, crack-resistant, and durable surface for interior walls and ceilings, ensuring excellent coverage, ideal setting, and a paint- or wallpaper-ready finish.



Premium
Finish



Nozzle
Packing



Less Paint
Consumption



Superior
Bonding

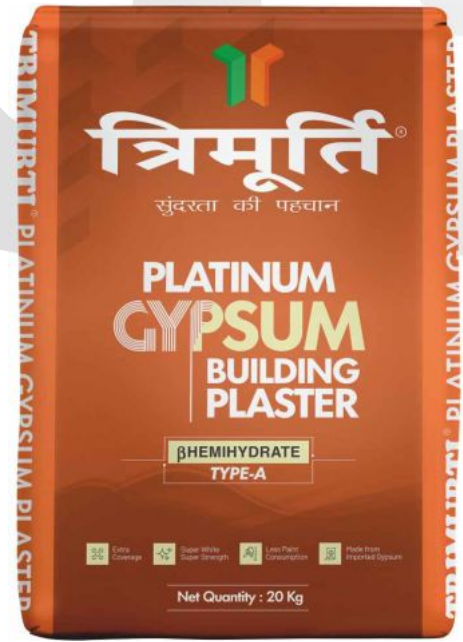

SPECIFICATIONS

Setting Time	:	15-20 min.
Residue	:	1%-2%
Whiteness	:	80%-82%
Wastage	:	NIL
Tensile Strength (kg/cm ²)	:	42-45
Compressive Strength (N/mm ²)	:	7-8
Density (kg/m ³)	:	675-700
Chemical Composition	:	Calcium Sulphate Hemihydrate [CaSO ₄ .1/2H ₂ O]
Material (1 kg)	:	0.7 Ltr. Water

COVERAGE

1 KG COVERS
1.25-1.5 SQ.FT. with 12MM THICKNESS

STORAGE & SHELF LIFE

12 MONTHS

from the date of manufacturing
when stored in dry conditions.

PACKAGING

20 KG

SILK GYPSUM PLASTER

Trimurti Silk Gypsum Plaster is a premium-quality plaster that delivers smooth, crack-free finishes with excellent adhesion. Ideal for interior walls, murtis, and chalk making & offers fine texture, and lasting durability. Perfect for decorative work, it ensures a flawless surface with superior strength and finish.



Extra
Coverage



Super
Smooth Finish



Super
Whiteness



Excellent
Adhesion



SPECIFICATIONS

Setting Time	:	15-20 Min
Residue	:	0.5-1%
Whiteness	:	88-90%
Wastage	:	NIL
Tensile strength (Kg/cm ²)	:	42-45
Compressive Strength (N/mm ²)	:	7-8
Density (Kg/m ³)	:	675-700
Chemical Composition	:	Calcium Sulphate Hemihydrate (Caso ₄ .1/2H ₂ O)
Material (1 kg)	:	0.7 Ltr. Water

COVERAGE

1 KG COVERS
1.25-1.5 SQ.FT. with 12MM THICKNESS

STORAGE & SHELF LIFE

12 MONTHS
from the date of manufacturing
when stored in dry conditions.

PACKAGING

2 KG

20 KG

ONE COAT GYPSUM PLASTER

Trimurti One Coat Gypsum Plaster is a lightweight, vermiculite-based plaster designed for red bricks, AAC blocks, and concrete walls. It eliminates the need for sand, cement, and P.O.P., offering superior insulation, strong adhesion, and a smooth, crack-free finish in a single, easy application.



Extra Coverage



No Water Curing Needed



No Shrinkage



Thermal Protection

SPECIFICATIONS

Setting Time	: 20-25 min.	Compressive Strength (N/mm ²)	: 5-7
Chemical % (Vermiculite)	: 5%	Density (kg/m ³)	: 840-880
Color of Finished Surface	: Off White	Water to Material Ratio	: 1:1.5
Tensile Strength (kg/cm ²)	: 30-40		

	Quality Assurance	Direct Application	Line & Level	Smooth Finish	Time Saving	Water Curing	Shrinkage Cracks	Fire Resistant	Heat Resistant	Light Weight Plaster	Drying Time
Sand Cement Plaster	—	✓	—	—	—	✓	✓	—	—	—	28 Days
P.O.P.	✓	—	✓	✓	—	Does Not Require	✓	—	—	✓	72 hrs
Trimurti One Coat Gypsum Plaster	✓	✓	✓	✓	✓	Does Not Require	Does Not Require	✓	✓	✓	72 hrs

COVERAGE

1 KG COVERS
0.50-0.60 SQ.FT. with 15MM THICKNESS

STORAGE & SHELF LIFE

12 MONTHS

from the date of manufacturing when stored in dry conditions.

PACKAGING

25 KG

40 KG

SUPERIOR QUICK BOND

Trimurti Superior Quick Bond is a premium green bonding agent that replaces the old method of hacking, ensuring strong plaster adhesion to smooth surfaces like concrete and RCC. Easy to apply with a brush or roller, it's ideal for modern construction and long-lasting surface bonding.



Applied on any
Concrete Surface



Ready
to Use



Make
Identification Easy



Dual
Bonding



SPECIFICATIONS

Dry Time	:	24 Hrs. (Depends on Weather)
Appearance	:	Green
Bonding Strength	:	18x-20x Than Conventional Hacking
Type	:	Colloidal Solution with Suspended Solids
Chemical Composition	:	Polymer Based Liquid
Application Tool	:	Brush or Roller
Density (kg/m ³)	:	1600-1650

**For better result do not mix with water

COVERAGE

**1 KG COVERS
30-32 SQ.FT. AREA**

STORAGE & SHELF LIFE

12 MONTHS

from the date of manufacturing
when stored in dry conditions.

PACKAGING



EXPERT QUICK BOND

Trimurti Expert Quick Bond is a high-performance bonding agent that replaces traditional hacking, boosting plaster adhesion up to 20 times. Its unique blend of sand fillers, adhesives, and polymers ensures strong bonding, easy brush application, and long lasting performance on concrete and RCC surfaces.



Applied on any
Concrete Surface



Ready
to Use



Extra
Coverage



Better
Strength



SPECIFICATIONS

Setting Time	:	24 hrs.
Color	:	Green
Bonding Time	:	20x Than Conventional Hacking
Type	:	Colloidal Solution with Suspended Solids
Chemical Composition	:	Polymer Based Liquid
Application Tool	:	Brush or Roller
Density (kg/m ³)	:	1600-1650

**For better result do not mix with water

COVERAGE

**1 KG COVERS
32-35 SQ.FT. AREA**

STORAGE & SHELF LIFE

12 MONTHS

from the date of manufacturing
when stored in dry conditions.

PACKAGING

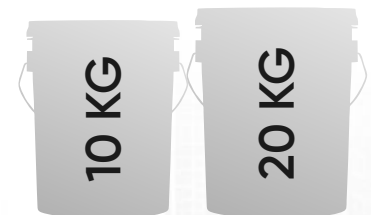

आ

Stylish

toh Vibe

priceless



GI GYPSUM BOARD & P.O.P CHANNEL

Trimurti GI P.O.P and Gypsum Board Channels are made from galvanized coated steel, providing excellent strength, stability, and corrosion resistance. Available in 8 ft. and 12 ft. sizes, they ensure precise alignment and a seamless finish, ideal for ceilings and partitions in all types of construction projects.



Logo
Engraved



ISI Certified
Raw Material



Extra
Gripping



Zig - Zag
Material



SPECIFICATIONS

Material	:	Galvanized Iron
Thickness	:	0.62 – 0.66mm
Gauge	:	24-28 Gauge
Surface	:	Zig - Zag
Logo Engraved	:	Yes
Corrosion Resistant	:	Yes
Strength	:	High

SIZES

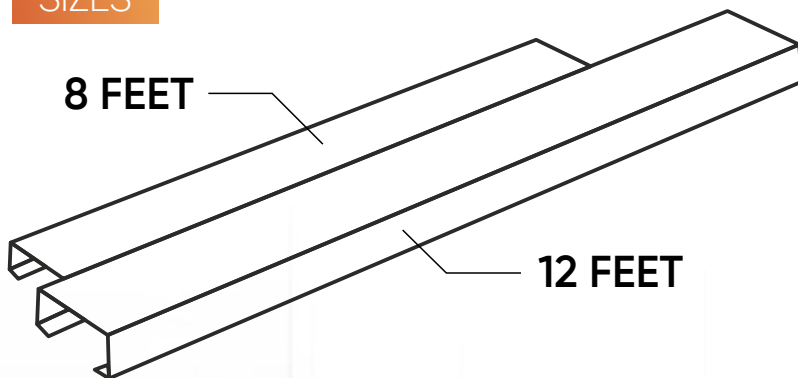

GI P.O.P WIRE MESH

Trimurti P.O.P. GI Wire Mesh is a high-quality galvanized iron mesh designed for strength and long-lasting performance in construction and interior works. With 4 meshes per inch, 0.54 mm wire thickness, and a 3 ft height, it reduces P.O.P. usage and is available in 4 kg, 8 kg, and 16 kg variants.



Less P.O.P.
Consumption



No Sagging



Without
Cardboard



Rust
Free



SPECIFICATIONS

1 Inches	:	4 Boxes
Wire Thickness	:	0.44mm to 0.58mm
Width	:	3ft.
Length	:	50ft.

PACKAGING



DRY WALL SCREW

Trimurti Drywall Screws are premium black zinc-coated screw designed for secure fixing of gypsum boards, P.O.P. and gypsum channels. With pointed ends for easy penetration and deep threads for a strong grip, they ensure reliable, long-lasting performance in wall and ceiling installations.



Supreme
Quality



Easy
Installation



Anti
Corrosive



Dimensional
Accuracy

SPECIFICATIONS

Coating	:	Zinc
Durability	:	High
Material Quality	:	Supreme Quality
Anti-Corrosion	:	Yes
Dimensional Accuracy	:	Standard
Top Head	:	Star
Bottom Head	:	Pointed
Color	:	Black

QUANTITY

1 BOX CONTAIN 1000 PIECES
1 MASTER BOX CONTAIN 20 BOXES

SIZES

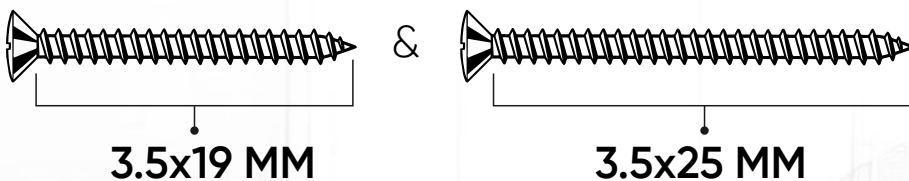

FASTENER

Trimurti Fasteners are premium 6mm brass components with a hexagonal head, designed for secure and precise fittings. With corrosion-resistant coating and fine threading, they ensure strength, stability, and long-term durability—ideal for construction, repair, and industrial use in modern building applications.



Supreme
Quality



Easy
Installation



Anti
Corrosive



Dimensional
Accuracy

SPECIFICATIONS

Material	:	Brass
Diameter	:	0.6 mm
Dimensional Accuracy	:	Standard
Size	:	6 mm
Head	:	Hexagonal
Gauge	:	17
Length	:	50 mm
Washer Thickness	:	1 mm
Thread	:	6 mm
Shell Length	:	35 mm
Shell Thickness	:	1.4 mm

QUANTITY

1 BOX CONTAIN 100 PIECES
1 MASTER BOX CONTAIN 12 BOXES

SIZES

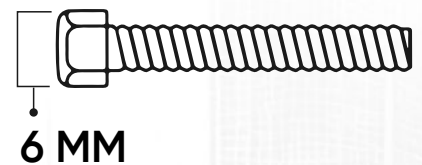

6 MM

KEEL

Trimurti Keel (Nail) is a small, pointed metal fastener with a flat head, ideal for fastening, hanging, and decorative use. Its silver-like GI-coated finish provides exceptional strength, corrosion resistance, and long-lasting performance in construction and woodworking applications.



Long-lasting Performance



Easy Piercing



Easy to Install



Strong Holding Strength

AREA OF APPLICATION



Hard Wood



Bricks



Cement Mortar Components



Decoration Industry



Hanging Frame



Furniture

PACK

BOX OF **500 PIECES**

MATERIAL TYPE

IRON (GI COATED)

SIZES

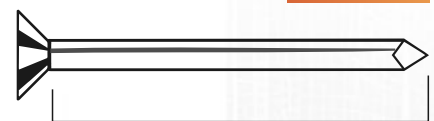

1.5 INCHES

WASHER

Trimurti P.O.P. Washer is crafted from iron with a GI-coated finish, ensuring corrosion resistance and durability. It securely fixes gypsum boards and false ceilings by evenly distributing screw load, preventing surface damage, and enhancing installation strength and reliability.



Corrosion Resistant



Easy to Install



Accurate Size



High Strength

AREA OF APPLICATION



False Ceiling Installations

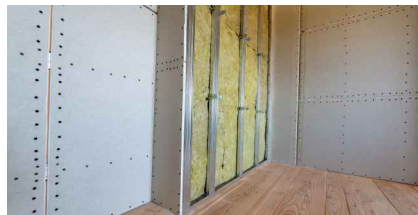

Drywall Partitions



P.O.P-Based Decorative Moldings And Wall Structures

PACK

BOX OF **500 PIECES**

MATERIAL TYPE

IRON (GI COATED)

SIZES

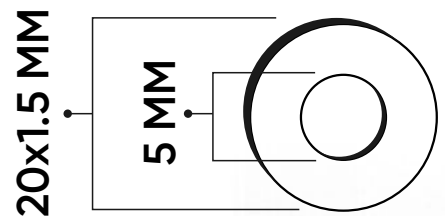

PREMIUM T - GRID

Trimurti T-Grid System is a high-performance false ceiling suspension framework designed to provide strong structural support, precise alignment, and a clean, professional finish. The system consists of three key components – Main T, Cross T, and Wall Angle – working together to create a stable and uniform grid structure. Manufactured from high-quality GI sheet, it ensures durability, corrosion resistance, and reliable long-term performance across various interior spaces.



Strong Structural Support



Tight Interlocking System



Corrosion Resistant



Demountable Design

SPECIFICATIONS

Components	:	Main T, Cross T, Wall Angle
Material	:	Hot-dip Galvanized Steel
Cross T Sizes	:	26mm x 24mm x 600mm
	:	26mm x 24mm x 1200mm
	Thickness	: 0.22mm
Main T Sizes	:	32mm x 24mm x 3600mm
	:	32mm x 24mm x 3000mm
	Thickness	: 0.22mm
Wall Angle Size	:	22mm x 22mm x 3000mm
	Thickness	: 0.30mm

VARITANTS

Main T



Cross T

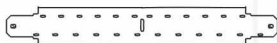

Wall Angle

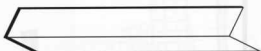

AREA OF APPLICATION

- Hospitals
- Residential Buildings
- Hotels
- Schools
- Offices & Corporate Buildings

PREMIUM CEILING TILES

Trimurti Premium PVC Laminated Gypsum Ceiling Tiles are high-performance false ceiling panels manufactured with a strong gypsum core and laminated with high-quality textured PVC film on the face side. The rear side is coated with protective backing to enhance durability and moisture resistance.

These ceiling tiles are designed to deliver superior aesthetics, improved light reflectance, and long-lasting structural stability for commercial and residential applications.



Easy
Installation



Humidity
Resistance



Light
Weight



High Light
Reflectance

SPECIFICATIONS

Tile Size	:	595 mm x 595 mm
Thickness	:	7 mm
Edge Type	:	Square Edge (S/E)
Core Material	:	High Quality Gypsum
Face Finish	:	Textured PVC Laminated Film
Rear Side	:	Protective Back Coating
Light Reflectance	:	Up to 80%
Packaging	:	Standard Bundle of 10 Tiles

VARIANTS

3 Premium Surface Designs

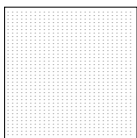

154

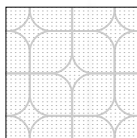

238

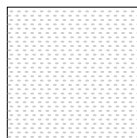

975

AREA OF APPLICATION

- Hospitals
- Residential Buildings
- Hotels
- Schools
- Offices & Corporate Buildings

GYPSUM BOARD

Trimurti Gypsum Board is a prefabricated panel with a gypsum core sandwiched between two paper sheets. Also known as drywall or plasterboard, it is ideal for interior walls, ceilings, and partitions, offering durability, quick installation, and cost-efficiency for residential, commercial, and industrial construction projects.



Light Weight Construction



Quick & Dry Installation



Cost Effective



Better Durability



SPECIFICATIONS

Weight	:	17-17.2 kg
Thickness	:	12-12.5 mm
Strength	:	High
Length	:	1830 mm
Width	:	1220 mm
Edge Profile	:	TE (Taper Edge)

STORAGE & SHELF LIFE

12 MONTHS

from the date of manufacturing when stored in dry conditions.

VARIANTS

- ✓ Premium Gypsum Board
- ✓ Fire Resistant Gypsum Board
- ✓ Heat Resistant Gypsum Board
- ✓ Moisture Resistant Gypsum Board

SIZES

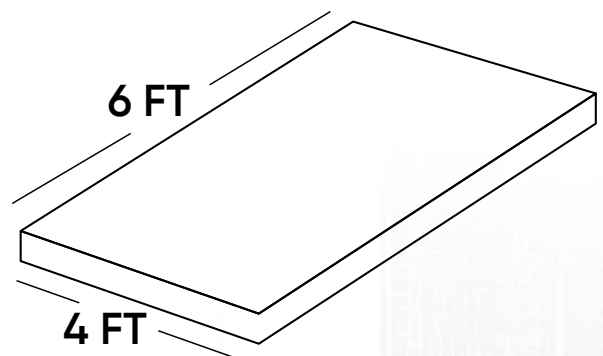

DRYWALL TAPE

Trimurti Drywall Tape is a high-strength, durable tape designed to reinforce drywall joints and prevent cracks. It offers excellent adhesion and a smooth, long-lasting finish. Ideal for interior walls and ceilings, it ensures stability and seamless results in drywall and gypsum board installations.



Prevents Cracks



Easy To Apply



Shrinkage Resistant



Self Adhesive

SPECIFICATIONS

Material	:	Fiberglass Yarn
Width	:	50 mm (2 inches)
Roll Length	:	50 meters & 90 meters
Mesh Size	:	3 mm × 3 mm (standard)
Thickness	:	~0.4 mm
Tensile Strength	:	≥ 8.0 kN/m

COVERAGE

**1 ROLL COVERS
APPROX 2.2–2.4 M²**

STORAGE & SHELF LIFE

24 MONTHS

from the date of manufacturing when stored in original, sealed packaging.

PACKAGING

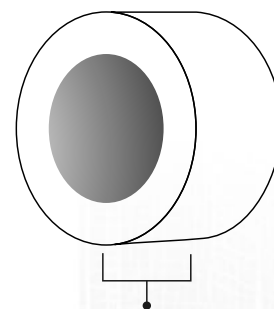

**50 mm x 50 mtr.
50 mm x 90 mtr.**

GYPSUM JOINTING COMPOUND

Trimurti Gypsum Jointing Compound is a high-performance solution for seamless jointing of gypsum boards. It ensures strong adhesion, excellent crack resistance, and a smooth finish ready for painting. Ideal for embedding joint tapes and filling gaps, it delivers flawless results in drywall and ceiling installations.



Paint-Ready Surface



Water Efficient



Excellent Coverage



Crack & Shrinkage Resistance



AREA OF APPLICATION



Joint filling and finishing in Gypsum Board systems



Embedding paper or fiber joint tapes



Repairing minor cracks and surface defects on gypsum boards



Achieving a level 5 drywall finish for premium interior surfaces

COVERAGE

25 KG COVERS
90-110 SQ.FT.

STORAGE & SHELF LIFE

12 MONTHS

from the date of manufacturing when stored in original, sealed packaging.

PACKAGING

25 KG

Walls ko do
**LUXURY
TOUCH**

Smooth Finish 

High Coverage 



PREMIUM WALL PUTTY

Trimurti Premium Wall Putty is a white cement-based finishing solution that delivers a smooth, durable, and flake-resistant surface for painting. Suitable for interior and exterior walls, it offers excellent adhesion, enhances paint life, and ensures a flawless, long-lasting finish on various surfaces.



Extra Coverage



Longer Paint Life



Smooth Finish



Water Resistant



SPECIFICATIONS

Water Demand	:	35-40%
Whiteness	:	85-90%
Compressive Strength (N/mm ²) (28 Days)	:	5-7
Tensile Adhesion Strength (N/mm ²) (14 Days)	:	1-1.5
Water Absorption (ml/hr) (14 Days)	:	0.2-0.3
Coating Thickness	:	1-1.5mm
Pot Life	:	2-3 Hours
Dry Bulk Density (kg/m ³)	:	1000-1050

COVERAGE

1 KG COVERS
15-18 SQ.FT. for 2 COATS

STORAGE & SHELF LIFE

12 MONTHS
from the date of manufacturing
when stored in dry conditions.

PACKAGING



SUPERIOR WALL PUTTY

Trimurti Superior Wall Putty is a premium white cement-based wall finish that delivers unmatched smoothness, strength, and durability. With excellent adhesion and high coverage, it prepares walls perfectly for paint. Ideal for interiors and exteriors & ensures a flawless, crack-free finish that truly lasts.



Prevent
Flakings



Enhance
Adhesion



Water
Resistant



Smooth
Finish

SPECIFICATIONS

Water Demand	:	35-40%
Whiteness	:	85-90%
Compressive Strength (N/mm ²) (28 Days)	:	5-7
Tensile Adhesion Strength (N/mm ²) (14 Days)	:	1-1.5
Water Absorption (ml/hr) (14 Days)	:	0.2-0.3
Coating Thickness	:	1-1.5mm
Pot Life	:	2-3 Hours
Dry Bulk Density (kg/m ³)	:	1000-1050

COVERAGE

1 KG COVERS
15-18 SQ.FT. for 2 COATS

STORAGE & SHELF LIFE

12 MONTHS
from the date of manufacturing
when stored in dry conditions.

PACKAGING

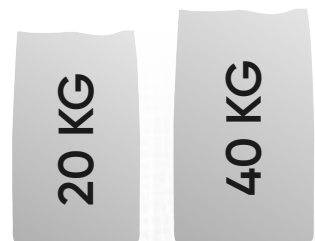

EXPERT WALL PUTTY

Trimurti Expert Wall Putty, enriched with advanced German polymers, delivers an ultra-smooth, durable surface with unmatched bonding and moisture resistance. Ideal for interiors and exteriors, it enhances paint vibrancy, prevents cracks and flaking, and ensures a flawless, long-lasting finish that brings walls to life.



For Interior & Exterior Walls



High Adhesiveness



High Durability



Less Paint Consumption



SPECIFICATIONS

Water Demand	:	35-40%
Whiteness	:	90-92%
Compressive Strength (N/mm ²) (28 Days)	:	7-8
Tensile Adhesion Strength (N/mm ²) (14 Days)	:	1.5-2
Water Absorption (ml/hr) (14 Days)	:	0.6
Coating Thickness	:	1-1.5mm
Pot Life	:	2-3 Hours
Dry Bulk Density (kg/m ³)	:	1050-1100

COVERAGE

1 KG COVERS
18-20 SQ.FT. for 2 COATS

STORAGE & SHELF LIFE

12 MONTHS
from the date of manufacturing
when stored in dry conditions.

PACKAGING

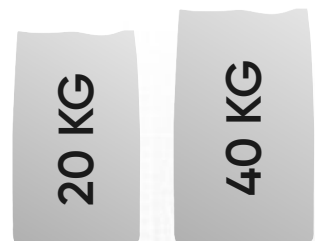

SILK WALL PUTTY

Trimurti Silk Wall Putty, crafted with Micro Particle Technology, delivers a flawless, pearl-like finish and unmatched whiteness. It offers superior coverage, strong adhesion, and a premium smooth base for painting. Ideal for interiors, it ensures long-lasting beauty and a luxurious finish on every wall.



Water
Resistant



Less Paint
Consumption



Smooth
Finish



High
Coverage



SPECIFICATIONS

Water Demand	:	35-40%
Whiteness	:	90-92%
Compressive Strength (N/mm ²) (28 Days)	:	6-8
Tensile Adhesion Strength (N/mm ²) (14 Days)	:	1.5-2
Water Absorption (ml/hr)	:	0.6
Coating Thickness	:	1-1.5mm
Pot Life	:	2-3 Hours

COVERAGE

1 KG COVERS
19-20 SQ.FT. for 2 COATS

STORAGE & SHELF LIFE

12 MONTHS
from the date of manufacturing
when stored in dry conditions.

PACKAGING

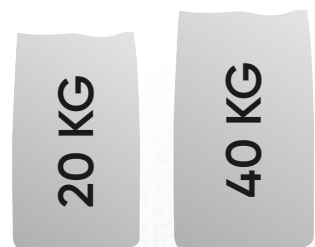

WATERPROOF WALL PUTTY

Trimurti Waterproof Putty is a premium white cement-based putty enriched with German silicone polymers. It offers excellent moisture resistance, forms a strong base on plaster or concrete surfaces, and protects walls from water damage. Ideal before paint or distemper, it ensures lasting durability and smooth finish.



Better
Whiteness



2X Water
Resistant



No Curing
Required



Prevent
Flakings



SPECIFICATIONS

Water Demand	:	35-40%
Whiteness	:	90-92%
Compressive Strength (N/mm ²) (28 Days)	:	6-7
Tensile Adhesion Strength (N/mm ²) (14 Days)	:	1.5-2
Water Absorption (ml/hr)	:	0.1-0.2
Coating Thickness	:	1-1.5mm
Pot Life	:	2-3 Hours

COVERAGE

**1 KG COVERS
19-22 SQ.FT. for 2 COATS**

STORAGE & SHELF LIFE

12 MONTHS
from the date of manufacturing
when stored in dry conditions.

PACKAGING



WALL PUTTY TONIC

Trimurti Wall Putty Tonic is an emulsion-based admixture that enhances the performance of all types of wall putty. It improves bonding, increases strength, resists cracks, and delivers a smoother, more durable finish. Ideal for both interior and exterior walls, ensuring long-lasting beauty and protection.



Strong
Adhesion



Glossy
Finish



Less Paint
Consumption



Extra
Coverage



AREA OF APPLICATION



Cement Plastered Walls



Precast Walls

USAGE

MIX **50 ML** WALL PUTTY TONIC WITH
1 KG TRIMURTI WALL PUTTY

STORAGE & SHELF LIFE

12 MONTHS

from the date of manufacturing
when stored in dry conditions.

PACKAGING

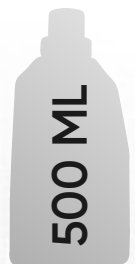

DECORATIVE WHITE CEMENT

Trimurti Decorative White Cement, crafted from best-class limestone, white aggregates, and polymers, delivers superior whiteness, smooth texture, and strong adhesion. Ideal for walls, decor, terrazzo floors, and precast elements, it boosts durability and aesthetics in paints, putties, adhesives, and decorative applications.



High Strength



Best Class Limestone Used



Extra Whiteness



Fills Crack



AREA OF APPLICATION



Glass Fiber Reinforced Concrete.



Garden Showcase Ornaments

STORAGE & SHELF LIFE

6 MONTHS

from the date of manufacturing when stored in dry conditions.

PACKAGING



Simplicity
mein hain
beauty



PEARL WHITE WASH

Trimurti Pearl White Wash is a premium, eco-friendly wall finish made from natural slaked lime and minerals. It creates a breathable, soft matte look that ages gracefully. Ideal for interior and exterior walls, it suits brick, plaster, and other porous surfaces with timeless elegance.



Antibacterial



Eco
Friendly



Brighter Walls
and Ceilings



Cost
Effective



SPECIFICATIONS

Appearance	:	Milky white liquid (after dilution)
Drying Time	:	Touch dry : 2-3 hrs, Full dry : 6-8 hrs
No. of Coats Recommended	:	2-3
Adhesion	:	Good (can be improved with binder/gum)

COVERAGE

**1 KG COVERS
120 SQ.FT. (DEPENDS ON SURFACE)**

STORAGE & SHELF LIFE

6 MONTHS

from the date of manufacturing
when stored in dry conditions.

PACKAGING

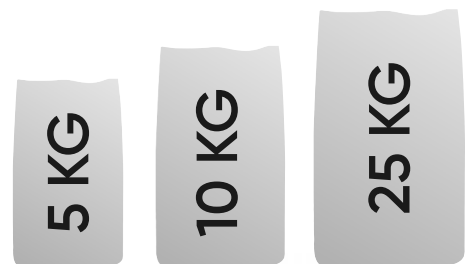

Dress your Space

with Vibrant Colours



Quick
Drying



Durability



CROMA ACRYLIC DISTEMPER

Trimurti Croma Acrylic Distemper Paint is a water-based, affordable, and long-lasting interior paint made with premium minerals and additives. It offers a smooth matte finish, excellent coverage, and strong adhesion, making it ideal for walls and ceilings in homes, offices, and commercial spaces.

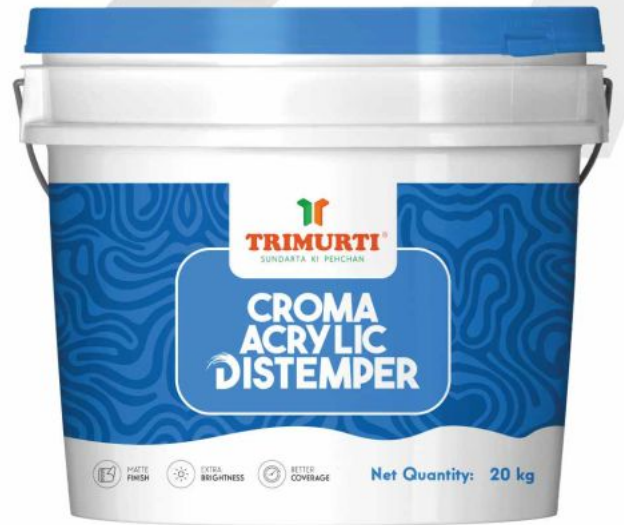

Eye Soothing
Matt Finish



Good Wash
Ability



Brighter and
Cleaner Shades



Cost
Effective

SPECIFICATIONS

Drying Time	:	3-4 Hours
Recoating	:	Min 4-6 Hrs.
Finish Type	:	Matte
Thinning	:	Up To 1 Ltr Of Water To 1.5 Kg Of Distemper
Stability Of Thinned Paint	:	Use Within 24 Hrs
Shell Life	:	2 Years
Application Tool	:	Roller, Spray & Brush
Appearance	:	Smooth White Liquid

COVERAGE

**1 LITRE COVERS
80-100 SQ.FT. AREA WITH 2 COAT**

**Actual coverage may vary depending on method, condition of application, surface roughness & shade.

PACKAGING



STORAGE & SHELF LIFE

24 MONTHS

from the date of manufacturing in the original tightly closed container, away from direct sunlight and excessive heat.

PRIMER PAINT COAT

(INTERIOR WALL PRIMER)

Trimurti Primer Paint Coat is a high-quality water-based wall primer that provides a smooth, durable base for interior walls. It enhances paint adhesion, offers uniform coverage, and protects against moisture and stains. Ideal for gypsum plaster, wall putty, and similar surfaces, it ensures a flawless finish.



Cover
Stains



Quick
Drying



Bright
White



Good
Coverage

SPECIFICATIONS

Drying Time	:	30 Mins
Suitable For	:	Interior Walls
Texture	:	Liquid
Stability Of Thinned Paint	:	Use Within 24 Hours
Finish	:	Matte
Appearance	:	Smooth White Liquid
Application Tool	:	Roller Spray & Brush

COVERAGE

1 LITRE COVERS
80-100 SQ.FT. AREA WITH
SINGLE COAT.

STORAGE & SHELF LIFE

24 MONTHS

from the date of manufacturing in the original tightly closed container, away from direct sunlight and excess heat.

PACKAGING

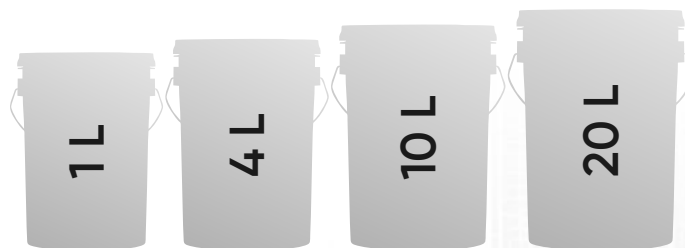

PRIMER SHIELD

(EXTERIOR WALL PRIMER)

Trimurti Primer Shield is a high-performance water-based primer for exterior walls. It offers superior adhesion, sealing, and durability, enhances emulsion performance, boosts topcoat coverage, and delivers a smooth, long-lasting finish for all types of exterior surfaces.



Long Lasting



Cover Stains



Superior Whiteness



Quick Drying



SPECIFICATIONS

Drying Time	:	30 Mins
Suitable For	:	Exterior Walls
Texture	:	Liquid
Stability Of Thinned Paint	:	Use Within 24 Hours
Finish	:	Matte
Appearance	:	Smooth White Liquid
Application Tool	:	Roller Spray & Brush

COVERAGE

1 LITRE COVERS
90-110 SQ.FT. AREA WITH
SINGLE COAT.

PACKAGING



STORAGE & SHELF LIFE

24 MONTHS

from the date of manufacturing in the original tightly closed container, away from direct sunlight and excess heat.

ELEGANT EMULSION

(INTERIOR EMULSION)

Trimurti Elegant Interior Emulsion is a premium water-based paint that enhances interior aesthetics with a rich, smooth matte finish. Formulated with advanced technology, it offers excellent coverage, long-lasting durability, and a vibrant, flawless look—perfect for creating sophisticated and beautiful interior spaces.



Smooth
Matte Finish



Excellent
Coverage



Long-Lasting
Durability



Washable
Surface



SPECIFICATIONS

Drying Time	:	30 Mins
Suitable For	:	Interior Walls
Texture	:	Liquid
Stability Of Thinned Paint	:	Use Within 24 Hours
Finish	:	Smooth
Appearance	:	Smooth White Liquid
Application Tool	:	Roller Spray & Brush

COVERAGE

1 LITRE COVERS
50-60 SQ.FT. for **2 COATS**

STORAGE & SHELF LIFE

24 MONTHS

from date of manufacture in original tightly closed containers away from direct sunlight and excessive heat.

PACKAGING



FUSION EMULSION

(EXTERIOR EMULSION)

Trimurti Fusion Emulsion is a high-quality water-based paint formulated for exterior walls. It resists harsh weather, including rain, sun, and pollution. Enriched with superior pigments and binders, it ensures long-lasting protection, vibrant aesthetics, and a durable, weather-resistant finish for any building exterior.



Weather
Resistance



Quick
Drying



Breathability



Higher
Sheen



SPECIFICATIONS

Drying Time	:	30 Mins
Suitable For	:	Exterior Walls
Texture	:	Liquid
Stability Of Thinned Paint	:	Use Within 24 Hours
Finish	:	Smooth
Appearance	:	Smooth White Liquid
Application Tool	:	Roller Spray & Brush

COVERAGE

1 LITRE COVERS
50-60 SQ.FT. for **2 COATS**

STORAGE & SHELF LIFE

24 MONTHS

from date of manufacture in original tightly closed containers away from direct sunlight and excessive heat.

PACKAGING



ELEGANT SHYNE EMULSION

(INTERIOR EMULSION)

Trimurti Elegant Shyne Interior Emulsion is crafted to bring lasting beauty and sophistication to your living spaces. With advanced Anti-Fade Technology, and superior washability, it keeps walls vibrant, clean, and fresh for longer, delivering a smooth finish and enduring performance for modern interiors.



Higher Sheen



Superior Washability



Long-Lasting Durability



Anti-Fade Technology

SPECIFICATIONS

Drying Time	:	30 Mins
Suitable For	:	Interior Walls
Texture	:	Liquid
Stability Of Thinned Paint	:	Use Within 24 Hours
Finish	:	Smooth
Appearance	:	Smooth White Liquid
Application Tool	:	Roller Spray & Brush

COVERAGE

1 LITRE COVERS
50-60 SQ.FT. for 2 COATS

*Actual coverage may vary, due to surface conditions & application methods.

STORAGE & SHELF LIFE

24 MONTHS

from date of manufacture in original tightly closed containers away from direct sunlight and excessive heat.

PACKAGING

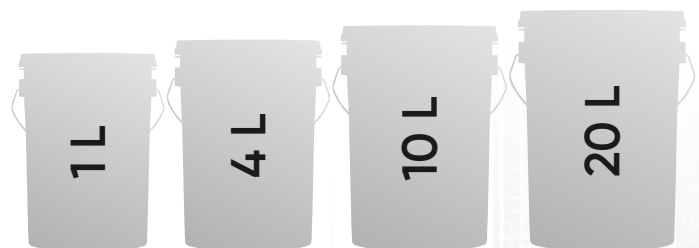

FUSION SHYNE EMULSION

(EXTERIOR EMULSION)

Trimurti Fusion Shyne Exterior Emulsion is engineered to protect and beautify your exteriors for years to come. Powered by advanced Weather Guard Technology, water-resistant properties, and anti-algal protection, it delivers lasting durability against harsh weather conditions while maintaining a rich, high-shheen finish that keeps your home looking fresh and elegant.



Water
Resistant



Anti-Algal
Formula



Anti-Fade
Technology



Higher
Sheen

SPECIFICATIONS

Drying Time	:	30 Mins
Suitable For	:	Exterior Walls
Texture	:	Liquid
Stability Of Thinned Paint	:	Use Within 24 Hours
Finish	:	Smooth
Appearance	:	Smooth White Liquid
Application Tool	:	Roller Spray & Brush

COVERAGE

**1 LITRE COVERS
50-60 SQ.FT. for 2 COATS**

*Actual coverage may vary, due to surface conditions & application methods.

STORAGE & SHELF LIFE

24 MONTHS

from date of manufacture in original tightly closed containers away from direct sunlight and excessive heat.

PACKAGING

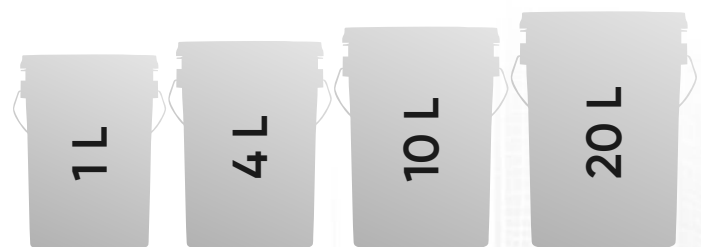

HAR GHAR ME

Khushiyon Ki Rangat



PREMIUM UNIVERSAL STAINER

Trimurti Universal Stainer is a high-strength, concentrated pigment dispersion designed to create vibrant and accurate shades in a wide range of paints. It is compatible with water-based paints, ensuring smooth mixing and uniform colour development for interior and exterior applications.



For Interior & Exterior Walls



Smooth Blending



Long Lasting Color



Easy to Apply

SPECIFICATIONS

Type	:	Concentrated pigment dispersion (binder-free / glycol-based)
Form	:	Liquid
Compatibility	:	Water-based Paints
Tint Strength	:	High (use $\leq 5\%$ for optimal results)
pH	:	~8-9
Specific Gravity	:	~1.1 - 1.7

SHADES

AVAILABLE IN 16 VIBRANT SHADES

- Fast Red
- Fast Green
- Fast Yellow Oxide
- Bright Green
- Mehandi
- Fast Violet
- Fire Red
- Fast Yellow
- Fire Orange
- Fast Yellow Green
- Burnt Sienna
- Turkey Umber
- Red Oxide
- Fast Black
- Fast Blue
- Magenta

STORAGE & SHELF LIFE

18-24 MONTHS

from date of manufacture in original tightly closed containers away from direct sunlight and excessive heat.

PACKAGING



50ml



100ml



200ml

ghar
rahe
safe
har season mein



HYDROPROOF WATERPROOFING SOLUTION

Trimurti Hydro Proof Waterproofing Solution is a liquid additive with plasticizers, polymers, and additives. It improves cement concrete, mortar, and plaster by ensuring uniform mix, preventing segregation, and enhancing waterproofing, strength, and durability for long-lasting, protected construction surfaces.



Corrosion Resistant



High Strength



Good Workability



Better Durability



SPECIFICATIONS

Appearance	:	Liquid
Color	:	Wine Red
Ph Value	:	11.0-14.0
Chloride Content	:	0.03%

USAGE

MIX **200 ML** IN
50 KG CEMENT BAG

STORAGE

Keep in a dry place free from moisture and water. Do not leave the bottle/bucket open.

PACKAGING



AQUACRETE WATERPROOFING SOLUTION

Trimurti Aquacrete Waterproofing Solution is a ready-to-use styrene butadiene rubber liquid for repairing concrete and waterproofing bathrooms, terraces, and more. It provides strong adhesion, reduces shrinkage, prevents cracks, improves abrasion resistance, and enhances overall structural durability.



Strong
Adhesion



Crack
Resistance



Durable
Bonding



Waterproof
Formula

SPECIFICATIONS

Appearance	:	Liquid
Color	:	Milky White
Type	:	Sbr Latex (styrene Butadiene Rubber Latex)
pH Value	:	7.7-7.9
Mixing Ratio	:	1:1.5 (Aquacrete : Cement)

COVERAGE

WATERPROOFING COATING
22-25 SQ.FT./KG IN 2 COATS

STORAGE

Keep in a dry place free from moisture and water. Do not leave the bottle/bucket open.

PACKAGING



PREMIUM GREY CEMENT

Trimurti Premium Grey Cement is a high-quality construction material made from finely ground clinker and gypsum. Available in 1 kg and 5 kg pouches, it ensures easy handling, zero wastage, and is ideal for quick repairs, plastering, and small construction jobs with lasting strength.



For Interior/
Exterior Use



For Repairing



No Wastage



Super
Adhesion



AREA OF APPLICATION



Bricklaying



Concreting



Repairing



Rendering

STORAGE & SHELF LIFE

12 MONTHS

from date of manufacture in original tightly closed containers away from direct sunlight and excessive heat.

PACKAGING



MARBLE & GRANITE KE LIYE

BEST
choice



TILE ADHESIVE

SILVER

Trimurti Silver Tile Adhesive is a high-performance adhesive for interior floor tiles of any size and thickness. Made with Korean polymer and 53-grade OPC cement, it offers superior bonding, eliminates the need for additional cement, and accelerates installation with maximum coverage and durability.



No Need To Add Cement



Fast Setting Time



Made with 53 Grade OPC Cement



Quick Drying



SPECIFICATIONS

Open Time	:	15 Mins.
Pot Life	:	1-1.5 Hours
Adjustable Time	:	30 Mins
Adhesive Type	:	Type 1 Ts1
Bulk Density	:	1400-1500 Kg/m ³
Appearance	:	Grey
Tensile Strength (28 Days)	:	0.95 N/mm ²

COVERAGE

1 KG COVERS
1-1.25 SQ.FT. with 8MM THICKNESS

STORAGE & SHELF LIFE

12 MONTHS

from the date of manufacturing, when stored in dry conditions.

PACKAGING

20 KG

TILE ADHESIVE

SILVER PLUS

Trimurti Silver Plus Tile Adhesive is a polymer-based adhesive made with Korean polymers and 53-grade OPC cement. Designed for fixing ceramic tiles on dry interior and exterior floors and interior walls up to 10 ft, it offers enhanced bonding, workability, and maximum coverage, ideal for tile-on-tile solutions.



No Need To Add Cement



Superior Bonding



Made with 53 Grade OPC Cement



Quick Drying



SPECIFICATIONS

Open Time	:	15 Mins.
Pot Life	:	1-1.5 Hours
Adjustable Time	:	35 Mins.
Adhesive Type	:	Type 2 Ts1
Bulk Density	:	1400-1500 Kg/m ³
Appearance	:	Grey & White
Tensile Strength (28 Days)	:	1.25 N/mm ²

COVERAGE

1 KG COVERS
1-1.25 SQ.FT. *with* 8MM THICKNESS

STORAGE & SHELF LIFE

12 MONTHS

from the date of manufacturing, when stored in dry conditions.

PACKAGING

20 KG

TILE ADHESIVE GOLD

Trimurti Gold Tile Adhesive is a high-precision, pre-mixed adhesive made with selected pigments, special aggregates, and 53-grade OPC cement. Ideal for ceramic & vitrified tiles, its sag-resistant formula ensures secure bonding for interior wall tiles up to 15 ft and sizes 2x2 ft to 32x64 inches, with excellent joint-filling properties.



No Need To
Add Cement



High
Strength



Made with 53
Grade OPC
Cement



Water
Resistance

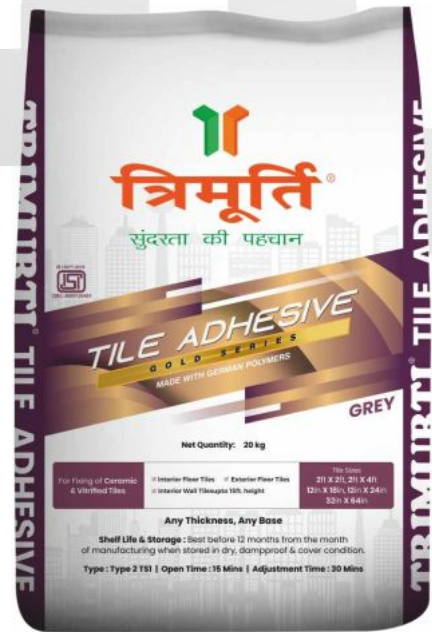

SPECIFICATIONS

Open Time	:	15 Mins.
Pot Life	:	1-1.5 Hours
Adjustable Time	:	30 Mins.
Adhesive Type	:	Type 2 Ts1
Bulk Density	:	1400-1500 Kg/m ³
Appearance	:	Grey
Tensile Strength (28 Days)	:	1.35 N/mm ²

COVERAGE

1 KG COVERS
1-1.25 SQ.FT. with 8MM THICKNESS

STORAGE & SHELF LIFE

12 MONTHS

from the date of manufacturing, when stored in dry conditions.

PACKAGING

20 KG

TILE ADHESIVE GOLD PLUS

Trimurti Gold Plus Tile Adhesive is a durable polymer-based adhesive made with 53-grade OPC cement, selected pigments, and special aggregates. Designed to withstand harsh weather, it offers strong, sag-resistant bonding for exterior wall tiles up to 50 ft and is ideal for interior and exterior marble, ceramic, vitrified, and porcelain tiles.



No Need To Add Cement



For Exterior Walls



Made with 53 Grade OPC Cement



Sag Resistant

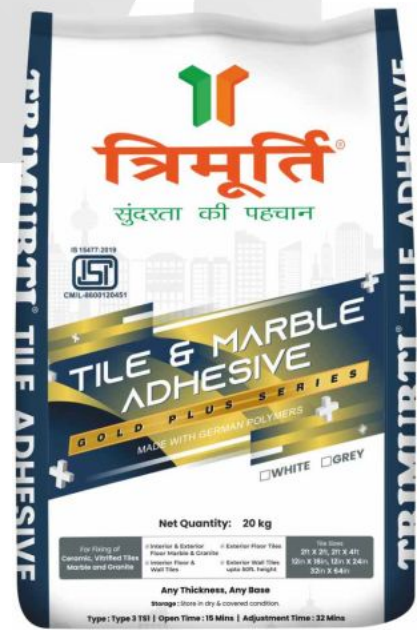

SPECIFICATIONS

Open Time	:	16 Mins.
Pot Life	:	1-1.5 Hours
Adjustable Time	:	32 Mins.
Adhesive Type	:	Type 3 Ts1
Bulk Density	:	1400-1500 Kg/m ³
Appearance	:	Grey & White
Tensile Strength (28 Days)	:	1.40 N/mm ²

COVERAGE

1 KG COVERS
1-1.25 SQ.FT. *with* **8MM** THICKNESS

STORAGE & SHELF LIFE

12 MONTHS

from the date of manufacturing, when stored in dry conditions.

PACKAGING

20 KG

TILE ADHESIVE DIAMOND

Trimurti Diamond Adhesive is a high-performance, polymer-modified adhesive formulated for large format tiles, marble, and granite of any size, height, or thickness. Ideal for interior and exterior use, it offers sag-resistant, durable bonding on walls and floors—requiring only water for application.



Non-sag &
Easy to Use



Better
Coverage



For Internal &
External Walls



High
Bonding

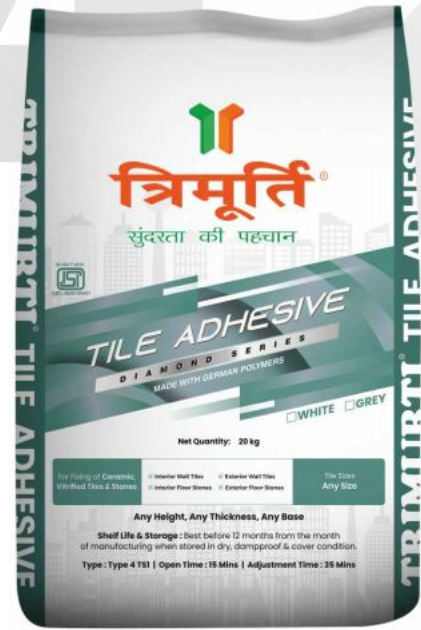

SPECIFICATIONS

Open Time	:	40 Mins.
Pot Life	:	1-1.5 Hours
Adjustable Time	:	50 Mins.
Adhesive Type	:	Type 4 T51
Bulk Density	:	1410-1450 Kg/m ³
Appearance	:	Grey & White
Tensile Strength (28 Days)	:	1.52 N/mm ²

COVERAGE

1 KG COVERS
1-1.25 SQ.FT. with **8MM** THICKNESS

STORAGE & SHELF LIFE

12 MONTHS

from the date of manufacturing, when stored in dry conditions.

PACKAGING

20 KG

The grout that

BEATS MOISTURE & STAINS



TILE/CEMENT BONDER

Trimurti Tile Bonder is a premium polymer additive that enhances cement slurry, ensuring strong bonding for tile and stone installations. It improves adhesion, flexibility, and durability, making it ideal for wall and floor applications in residential, commercial, and industrial settings.



Increase
Strength



High Adjustable
Time



Cement
Additive



Economical



SPECIFICATIONS

Appearance	:	White Powder
Bulk Density	:	0.75 g/ml
Open Time Approx.	:	20 Minutes
Adjustability Approx.	:	20 Minutes
Setting Time	:	24 hours
Tensile Strength	:	0.5-0.7 N/mm ²

RECOMMENDED RATIO

**300 GM TO BE MIXED IN
50 KG BAG OF CEMENT**

Coverage will vary depending on thickness of leveling bed.

STORAGE & SHELF LIFE

12 MONTHS

Original unopened packaging stored in dry condition.

PACKAGING

300 GM

PREMIUM UNSANDED TILE GROUT

Trimurti Tile Grout offers a smooth, crack-free finish for 1mm–5mm joints. Suitable for indoor and outdoor use, it resists shrinkage, cracking, and stains. Available in 30 vibrant colors, it ensures perfect tile matching and long-lasting aesthetics across various tiled surfaces.



Uniform
Color



Crack
Resistant



Water
Resistant



Add
Flexibility



SPECIFICATIONS

Color	:	As Per Shade Card
Water Demand	:	27-28%
Flexural Strength (28 Days) Mpa	:	2-3
Pot Life	:	1 Hours
Density (kg/cm ²)	:	1400-1500
Finish Type	:	Smooth & Excellent
Pull Out Strength (28 Days)	:	0.5 Mpa with 3mm Thickness

COVERAGE

DEPENDS ON **DEPTH & WIDTH**
OF THE JOINT

STORAGE & SHELF LIFE

6 MONTHS

from the date of manufacturing, when stored
in dry conditions.

PACKAGING

1 KG

TILE GROUT ADMIX

Trimurti Tile Grout Admix is a specially formulated liquid additive that replaces water in unsanded Grout mixes. It significantly enhances bond strength, flexibility, and durability, while also reducing setting time. Ideal for improving the performance and longevity of tile joints, it ensures a smoother application and a stronger, more resilient finish.



Reduces Water Absorption



Easy To Clean



Improves Flexibility & Durability Of Grout



Higher Compressive Strength



AREA OF APPLICATION



Used in Place of water in Grout.



For Interior & Exterior floor & wall joints.

RECOMMENDED RATIO

400 ML ADMIX TO BE MIXED IN
1 KG TILE GROUT

PACKAGING

400 ML

EPOXY GROUT (3 COMPONENT)

Trimurti 3-Component Epoxy Grout is a high-performance tile joint filler consisting of resin, hardener, and filler powder. Designed for areas requiring chemical resistance and hygiene, it offers excellent bonding, stain resistance, and a seamless finish—ideal for bathrooms, kitchens, industrial floors, and wet areas.



Easy
To Apply



High
Strength



Shrinkage
Free



Stain
Free

SPECIFICATIONS

Compressive Strength	:	79.8 N/mm ²
Tensile Strength	:	13.3 N/mm ²
Pot Life	:	40 - 45 Min.
Mix Density (Kg/cm ²)	:	1700-1800
Shrinkage	:	0.6%
Heavy Foot Traffic	:	72 Hours
Flexural Strength	:	32.4 N/mm ²
Water Cleanability	:	80 Mins.

COVERAGE

DEPENDS ON **DEPTH & WIDTH**
OF THE JOINT

STORAGE & SHELF LIFE

12 MONTHS

from the date of manufacturing, when stored
in dry conditions.

PACKAGING



EPOXY GROUT (2 COMPONENT)

Trimurti 2-Component Epoxy Grout is a durable, stain-resistant tile filler made of resin and hardener. Ideal for wet and high-traffic areas, it offers strong bonding and a hygienic, easy-to-clean finish. It creates a seamless, waterproof finish, ideal for kitchens, bathrooms, pools, and industrial spaces.



Waterproof



Acid & UV
Resistant



Stain
Resistant



For Interior
& Exterior

SPECIFICATIONS

Compressive Strength (Dry)	:	69.3 Mpa
Tensile Strength	:	16.79 Mpa
Pot Life	:	85- 90 Min.
Mix Density (Kg/m ³)	:	1600-1620
Shrinkage	:	0.11 %
Heavy Foot Traffic	:	72 Hours
Flexural Strength (Dry)	:	32.2 Mpa
Water Cleanability	:	80 Mins.

COVERAGE

DEPENDS ON **DEPTH & WIDTH**
OF THE JOINT

STORAGE & SHELF LIFE

12 MONTHS

from the date of manufacturing, when stored
in dry conditions.

PACKAGING



TILE CLEANER

Trimurti Tile Cleaner is a powerful, rapid-action solution for removing stains from ceramic, vitrified, and mosaic tiles. Infused with hydrogen peroxide and citric acid, it penetrates deeply to dissolve dirt and grime, leaving surfaces spotless, fresh, and shining with minimal effort.



Removes
Stains



Low
Maintenance



Shiny Tiles



Ideal For
Interior & Exterior



SPECIFICATIONS

Appearance	:	Liquid
Color	:	Pale Red
pH Value	:	5-6

AREA OF APPLICATION



Ceramic Tile



Porcelain Tile



Vitrified Tile

COVERAGE

DEPENDS ON **POROSITY OF STAINS**
OF THE JOINT

STORAGE & SHELF LIFE

24 MONTHS

from the date of manufacturing, when stored
in dry conditions.

PACKAGING

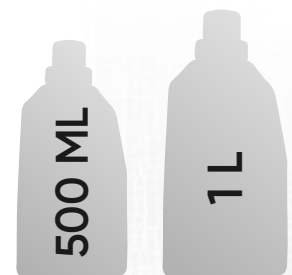

MARBLE CLEANER

Trimurti Marble Cleaner is a non-acidic, safe formula designed for daily cleaning of marble, tiles, and natural stone. Perfect for high-traffic areas like malls and hotels, it gently removes dirt without damaging surfaces, maintaining long-lasting shine, cleanliness, and surface integrity.



Bio
Degradable



Non
Corrosive



Removes
Stains



Effective Against
Lime Scales



AREA OF APPLICATION



Floors



Walls



Kitchens



Bathrooms



Heavy
Trafficked Areas

COVERAGE

DEPENDING ON THE
POROSITY OF SURFACE

STORAGE & SHELF LIFE

24 MONTHS

from the date of manufacturing

PACKAGING



TILE SPACER

Trimurti Tile Spacer ensures precise, uniform gaps between tiles during installation, preventing moisture seepage and enhancing bonding. Available in multiple sizes, it improves alignment and speeds up tile laying, delivering a polished, durable finish ideal for both wall and floor tile applications.



Uniform
Lines



Consistent
Spacing



Allows
Expansion



Prevents
Cracking



SPECIFICATIONS

Type	:	Tool
Usage	:	Consistent Spacing
Application	:	Wall & Floor
Shape	:	Plus
Color	:	White
Material	:	HDPE
Durability	:	High

SIZES

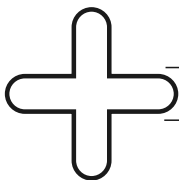

2 mm, 3 mm, 4 mm, 5 mm, 6 mm

NOTCH TROWEL

Trimurti Notch Trowel is a professional tool designed to apply tile adhesive evenly with its notched edge, ensuring consistent thickness and superior coverage. Ideal for both wall and floor tiling, it improves tile grip, alignment, and guarantees a strong, durable, and professional finish every time.



Less Time
Consumption



Easy
To Apply



Full Coverage with
Better Bonding



Proper
Leveling



SPECIFICATIONS

Type	:	Tool
Application	:	Wall & Floor
Shape	:	Long Round
Material	:	Stainless Steel
Width	:	127 mm
Long	:	254 mm
Handle Color	:	Orange
Adhesion of Tiles	:	Excellent

SIZES

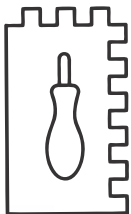

3 mm, 4 mm, 5 mm,
6 mm, 8 mm & 10 mm

DEEWARON KO DO NAYI LIFE

Smooth & Flawless

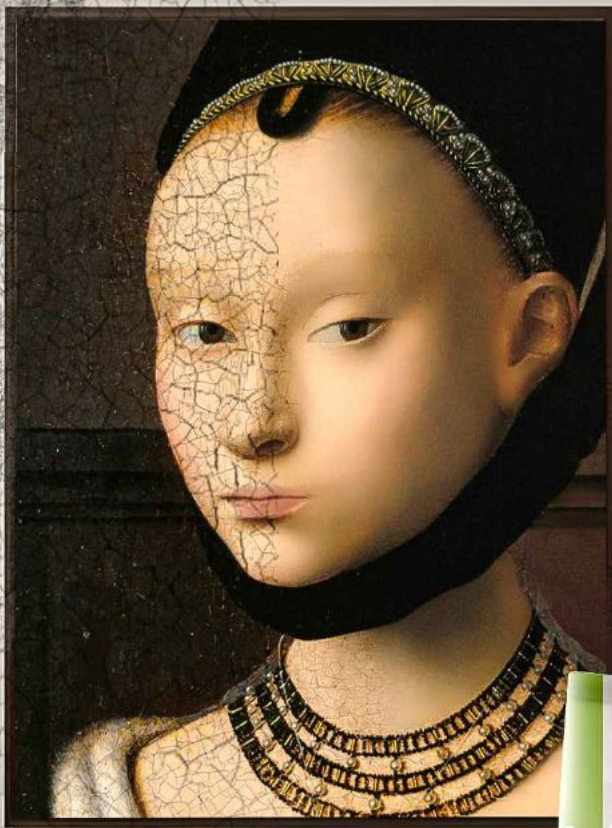

Crack
Free Walls



Bonding
Strength



READY MIX PLASTER

Trimurti Ready Mix Plaster is a polymer-modified, ready-to-use plaster made from 53-grade OPC cement (Grey & White). It provides excellent adhesion, water resistance, and a smooth, crack-free finish for internal and external walls—offering a perfect base for painting while ensuring faster, durable construction.



Less Curing
& Wastage



For Interior &
Exterior Walls



Double
Packaging



Made with OPC
53 Grade Cement



SPECIFICATIONS

Bulk Density	:	1500-1600 kg/m ³
Comprehensive Strength	:	14.9 N/mm ²
Bond Strength	:	0.55 N/mm
Pot Life	:	260-70 Minutes
Water Powder Ratio	:	20-22% by weight
Water Curing	:	2-3 times for 2-3 days
Dry Density	:	1900-1950 Kg/m ³
Appearance	:	Grey & White

COVERAGE

30 KG COVERS
10-12 SQ.FT. *with* THICKNESS UPTO **15MM**

PACKAGING

30 KG

STORAGE & SHELF LIFE

12 MONTHS

from the date of manufacturing, provided the original unopened packaging is stored in dry conditions

BRICK JOINING MORTAR

Trimurti Brick Joining Mortar is a ready-to-use, high-quality mortar made from cement, graded sand, and special additives. Ideal for red and fly ash bricks, it offers superior bonding, strength, and stability—eliminating the need for traditional mortar. Just add water for hassle-free application.



Cost Effective



Superior Bond & Self Curing



Double Packaging



Made with OPC 53 Grade Cement

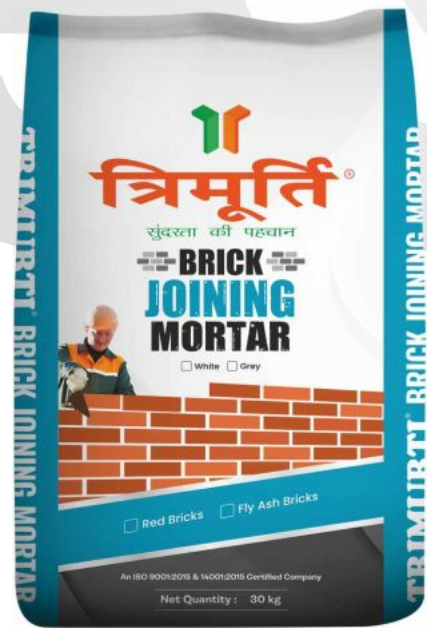

SPECIFICATIONS

Water Powder Ratio	:	25-30% by Weight
Water Curing	:	1-2 Times For 2-3 Days
Appearance	:	Grey & White
Wastage	:	Nil
Thickness	:	10-12 Mm
Suitable For	:	Red Bricks / Fly Ash Bricks

COVERAGE

30 KG COVERS 5-6 SQ.FT.

PACKAGING

STORAGE & SHELF LIFE

12 MONTHS

from the date of manufacturing, provided the original unopened packaging is stored in dry conditions

30 KG

AAC BLOCK JOINING MORTAR

Trimurti AAC Block Joining Mortar is a premium, ready-to-use adhesive formulated for AAC blocks, fly ash bricks, and concrete blocks. It ensures strong, durable bonding, replaces traditional mortar, and enables faster construction with superior finish, reduced material wastage, and minimal effort.



Construction Accuracy



High Strength



Less Storage Space



Self Curing



SPECIFICATIONS

Thickness	:	3 mm
Water Ratio	:	9-9.5 Litre
Bulk Density (Kg/m ³)	:	1600-1650
Wastage	:	Nil
Bond Strength (N/mm ²)	:	1 - 1.25
Appearance	:	Grey
Pot Life (In Min)	:	70-75
Compressive Strength (N/mm ²)	:	15 - 15.5

COVERAGE

30 KG COVERS 1 CUBIC METRE

STORAGE & SHELF LIFE

12 MONTHS

from the date of manufacturing, provided the original unopened packaging is stored in dry conditions

PACKAGING

30 KG



TRIMURTI®

SUNDARTA KI PEHCHAN



Trimurti Wall Care Products Pvt. Ltd.

✉ info@trimurtiprducts.com | 🌐 www.trimurtiprducts.com

Toll Free: 1800 1200 620

📱 🌐 📺 📺 /trimurtiprducts

